

## PRODUCT FEATURES:

- Smart-Play Integration system allows connection of Android and other phones to the Lexus infotainment system.
- Integrates Wired/Wireless Android Auto and CarPlay.
- Utilizes factory microphone for voice controls.
- Uses the factory Jog Wheel and steering wheel control buttons for Smart-Play controls.
- Connects to the factory Aux Input.



Jog Wheel Controls



Steering Wheel Controls

## PARTS INCLUDED:



ACPLX-12YW Module



Main Harnesses



Smart-Play Interface Module



GVIF Video Cables



4K HDMI Cable



USB Extension Cable  
(Optional)



**WIRING DIAGRAM:**

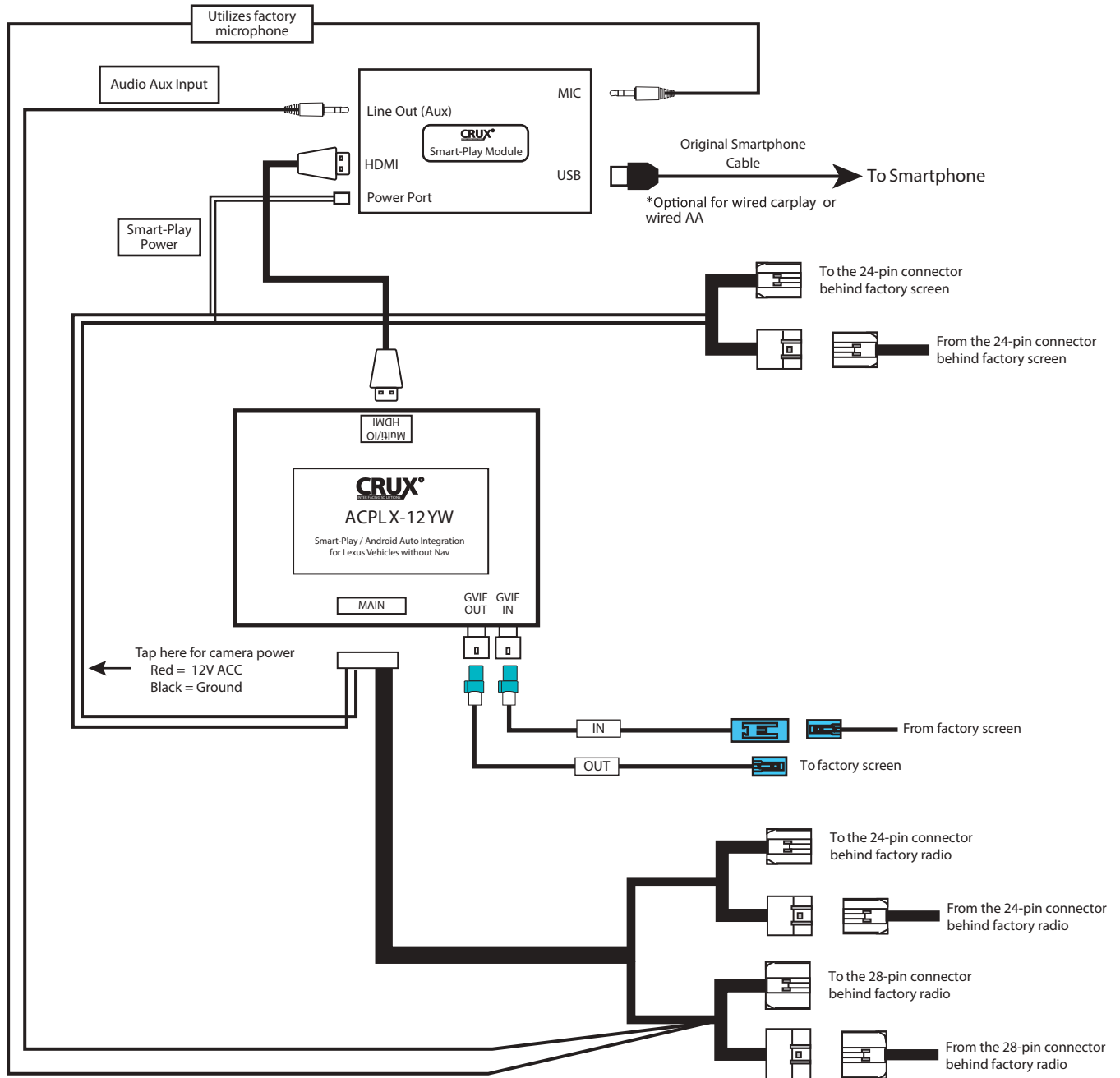

**DIP SWITCH SETTINGS:**



DIP	SETTING	VEHICLE
2, 5, & 7	DOWN (rest UP)	2010~2019 RX 8", 2015 NX 7", 2013~2019 IS 7", 2013~2019 RC 7" 2013~2018 ES 8", CT 7" 2014~2017, 2014~2020 GS 8"
2, 5, & 6	DOWN (rest UP)	2011~2013 CT200 7"
2, 5, 6, & 7	DOWN (rest UP)	2013~2018 ES 8" (Type 2)
4*	DOWN	Turn dip switch 4 ON if the tack down button on steering wheel does not work

*On vehicles with a 12.3" screen, you can change the screen resolution to show 5 horizontal App icons.*

Set "Android Auto Link:"  
to ON for Android Auto

Set "CP" to 1024 x 600  
Set "AA" to 1024 X 600

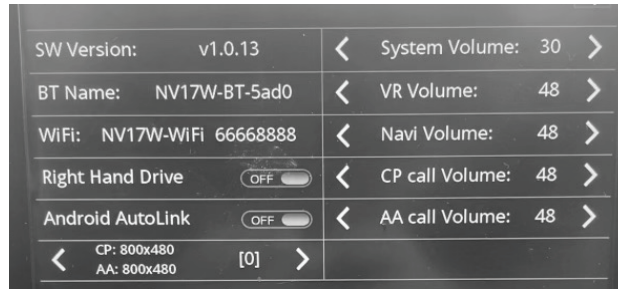

**WIRELESS CARPLAY/WIRELESS ANDROID AUTO CONNECTION SETTINGS**

Android Auto Wireless connection

Have Andriod AutoLink OFF

Have wifi & Bluetooth enabled.



**Apple Carplay Wireless Connection**

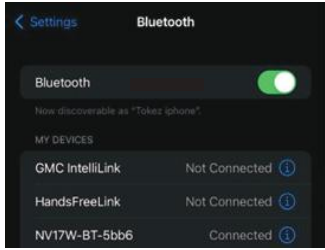

Have wifi & Bluetooth Connected

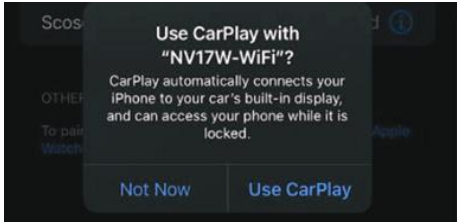

Wait for screen that will state  
Use Carplay with "NVF17W-WIFI"

**SMARTPHONE MIRRORING CONNECTION**

**Smartphone Mirroring Connection for Iphones**

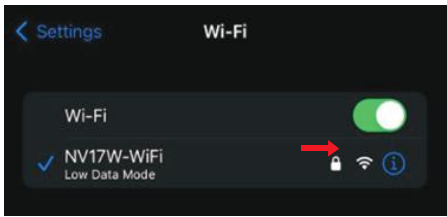

Enable Wi-Fi and connect to " NV17W " module

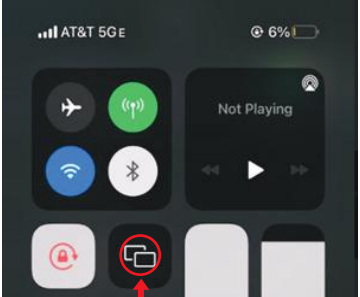

Open Control Center and Tap Screen Mirroring

- a. On iPhone X or later; iPad with iPadOS 13 or later: Swipe down from the upper-right corner of the screen.
- b. On iPhone 8 or earlier or IOS 11 or earlier: Swipe up from the bottom edge of screen

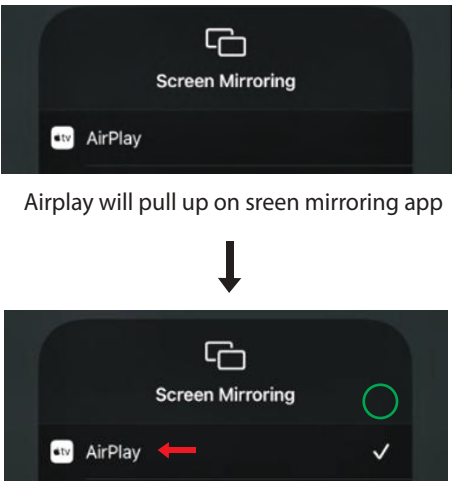

Airplay will pull up on screen mirroring app

↓

Select " Airplay "

**Smartphone Mirroring Connection for Androids**

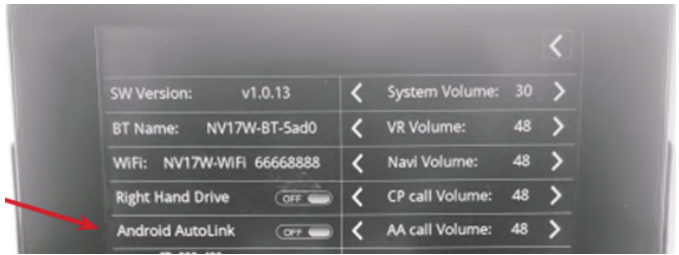

Enable Android AutoLink

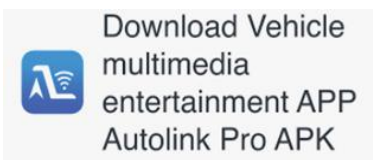

Download Vehicle multimedia entertainment APP Autolink Pro APK

↓

Download AutoLink Pro APP Available in the "Play Store"

**Smartphone Mirroring Connection for Androids continued**

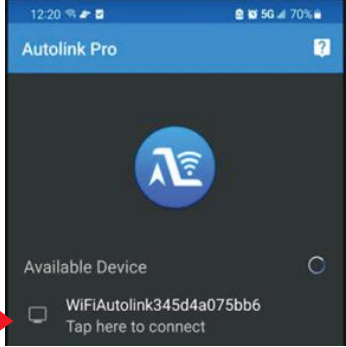
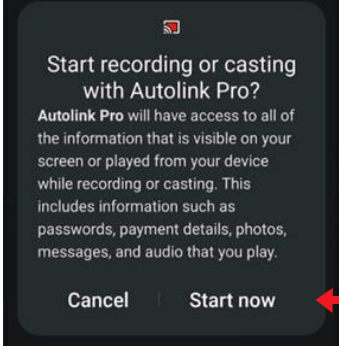
 <p>On AutoLink Pro APP find the Device and Tap to Connect</p>	 <p>Select "Start Now"</p>
-------------------------------------------------------------------------------------------------------------------------------------------------	--------------------------------------------------------------------------------------------------------------

**INSTALLATION INSTRUCTIONS:**

NOTE: Connections are made behind the radio and behind the screen.



1. Remove the trims on both sides of the center console.



2. Remove the right and left side trim along the center console.



3. Remove the Jog Wheel console and unplug the harness.





4. Remove the gear shift knob.



5. Remove the screw under the gear shifter panel.

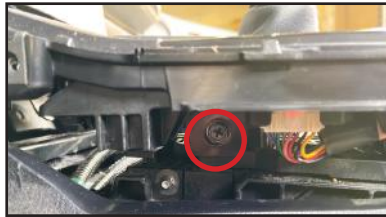

6. Remove the gear shifter panel and set aside.



7. Remove the screws holding the headunit.



8. Remove the headunit and the climate control panel.



9. Remove the glove box to gain access for mounting the ACPLX-12YW modules.



10. Use a pry tool to remove the trim in front of the screen. Remove the screws.



11. Run the ACPLX-12YW harness from the glove box area to the screen.



12. Make the power and LVDS connections on the factory screen.

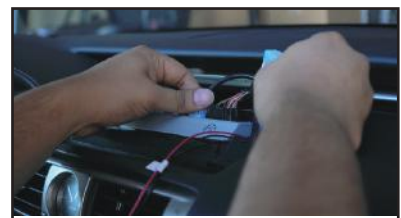



13. Make the connections behind the headunit.



14. Plug in the power harness and LVDS connections to the ACPLX-12YW module.



15. Plug in the power plug, HDMI, mic, aux-in, and USB extension to the Smart-Play module.



16. Mount the ACPLX-12YW modules behind the dash and test before reinstalling the whole dash area.

## AUDIO INPUT TO VEHICLE:

The Smart-Play audio will connect to the vehicle's audio system via the factory Aux input. Change the factory radio "Audio Source" to "AUX" in order for the Smart-Play audio to be heard on the factory audio system.

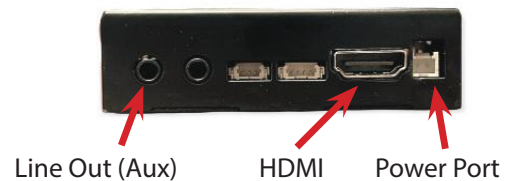

Line Out (Aux)

HDMI

Power Port

## MICROPHONE CONNECTION:

The Smart-Play will utilize the vehicle's factory microphone. Plug in the 3.5mm microphone connector on the ACPLX-12YW harness to the Smart-Play module microphone port to use the factory microphone.



Mic In

USB



**OPERATION:**

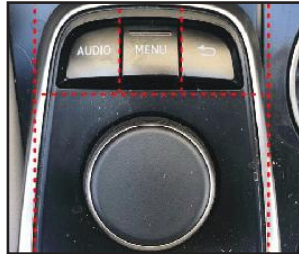

JOG WHEEL CONTROLS	
AUDIO	Activate Siri or Google voice command
MENU	Long press = Activate CarPlay / Android Auto   Short press = back to OEM screen
RETURN	Back to OEM screen menu
JOG WHEEL	Apple CarPlay and Android Auto controls
STEERING WHEEL CONTROLS	
Up /Down	Music Track Up/Down

**VEHICLE APPLICATIONS:**

Compatible with Lexus vehicles without OEM Navigation.

Lexus			
2014-2017	CT 200h	2014-2020	IS 250 / 200t / 300 / 350
2015-2018	ES 350 / 300h	2015-2019	RC 200t / 250 / 300 / RC F
2015-2017	NX 200t / 300h	2016-2019	RX 350 / 450h





**TROUBLESHOOTING**

\*If your call audio does not use car's bluetooth, manually change it on the phone to select the vehicle during the call, then the phone should remember the last used setting

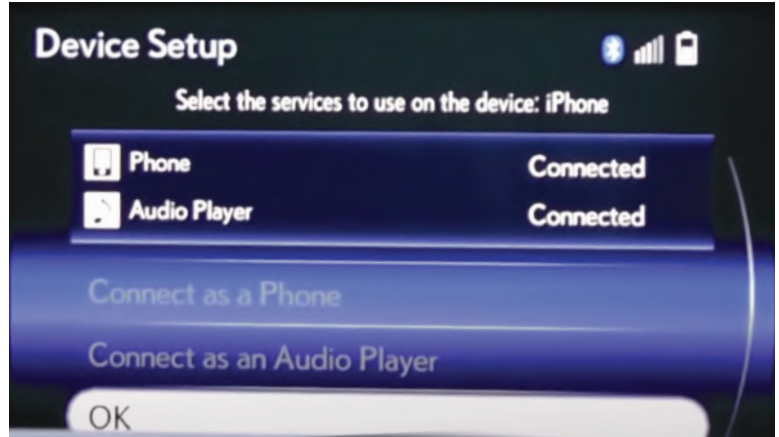
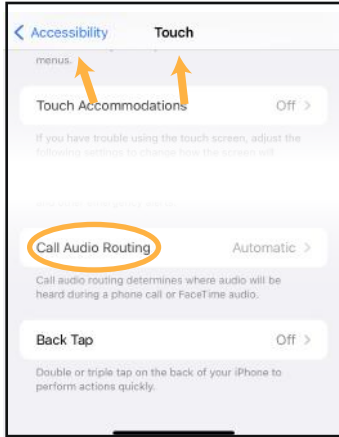

Changing the call audio routing setting to "BLUETOOTH HEADSET"

Go to Settings - Accessibility - Touch - Call Audio Routing. Keep it at "Automatic"

- 1. IF the screen is black & not showing factory infotainment screen or the CarPlay/Android Auto Screen**
  - Confirm secure connection of GVIF cables to the top monitor.
  - Confirm GVIF cables are not damaged, pinched, kinked or bent.
- 2. No trigger issue /No click heard when long hold applied on Menu button**
  - Check and confirm proper connection of the Main Car Interface Harness, CAN bus board, and 30-pin Car Interface Harness.
  - Check and confirm no loose pins or damage to the harness. Green/RED LED Light should be visible from the Metal Box
- 3. When long hold is applied on Menu button, black screen appears**
  - Confirm proper secure connection of the HDMI Cable.
  - Confirm power wire is connected on the CarPlay Box. Red LED light should be visible from the CarPlay Box.
- 4. Screen image glitching or distorted**
  - Confirm correct dip switch setting.
- 5. Hands free call quality noise and echo**
  - For iPhone, confirm the phone is connected to your vehicle via Bluetooth and "Call Audio Routing setting" Keep it at "Automatic"
  - For Android, confirm Bluetooth is being used for calls by observing phone's call audio output.
- 6. No sound**
  - Confirm AUX cable connection, which is on the HDMI side of the CarPlay Box.
  - Confirm Car Media Source is in AUX mode. Confirm sound output from the phone to CarPlay Module.
- 7. Siri does not recognize my voice**
  - Confirm Microphone jack connection (3.5mm), which is on the USB side of the CarPlay Box.
  - Confirm that there are no wire damage.
- 8. Switching from Smart-Phone Mirroring to CarPlay/Android Auto**
  - If device is unresponsive or glitching, turn vehicle off and allow module to sleep then try again.

