



PRODUCT FEATURES:

- Retains factory features in select GM LAN 29 Bit vehicles while functioning with an aftermarket radio.
 - Pre-programmed to retain factory Steering Wheel Controls.
 - Retains OnStar, factory Rear view camera and chime functions.
 - Adds Forced Rear view and Front view camera while in motion using the factory side mirror controls.
 - Supports Bose, non-Bose and Y-91 audio systems.
 - EIA color coded wiring for easy installation.
 - Includes Double DIN Dash Kit
1. The Front and Rear fading are not retained on Y-91 Bose System.
 2. Chime includes: seat belt, check engine, key in ignition, low fuel, low oil and lights on.

NOTES:



Double Din Dash Kit



DKGM-16W Module



DKGM-16W Harness



Video Harness



Antenna Adaptor



SWC Cable

DIP SWITCH SETTINGS:

SETTING THE AFTERMARKET RADIO BRAND

With the key in the off position, set the DIP switches to the corresponding aftermarket radio setting.

RADIO BRAND:	DIP:	1	2	3	4
Dual, Fahrenheit, Jensen, Pioneer		OFF	OFF	ON	ON
Power Acoustik, Soundstream		OFF	OFF	ON	ON
Alpine		OFF	OFF	OFF	OFF
Clarion		OFF	ON	ON	OFF
Kenwood		OFF	ON	ON	ON
JVC		OFF	ON	OFF	ON
Sony, Boss		OFF	ON	OFF	OFF

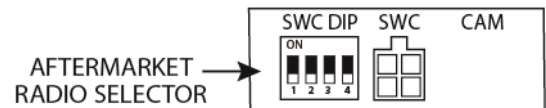

3.5MM SWC CABLE

Plug in the 4-Pin SWC cable to the 4-pin connector plug on the module.

NOTE: Cap or insulate the 3.5mm plug, the Blue/Yellow or Green wires if not being used.

SWC 3.5MM PLUG ADAPTER:





INSTALLATION DIAGRAM:

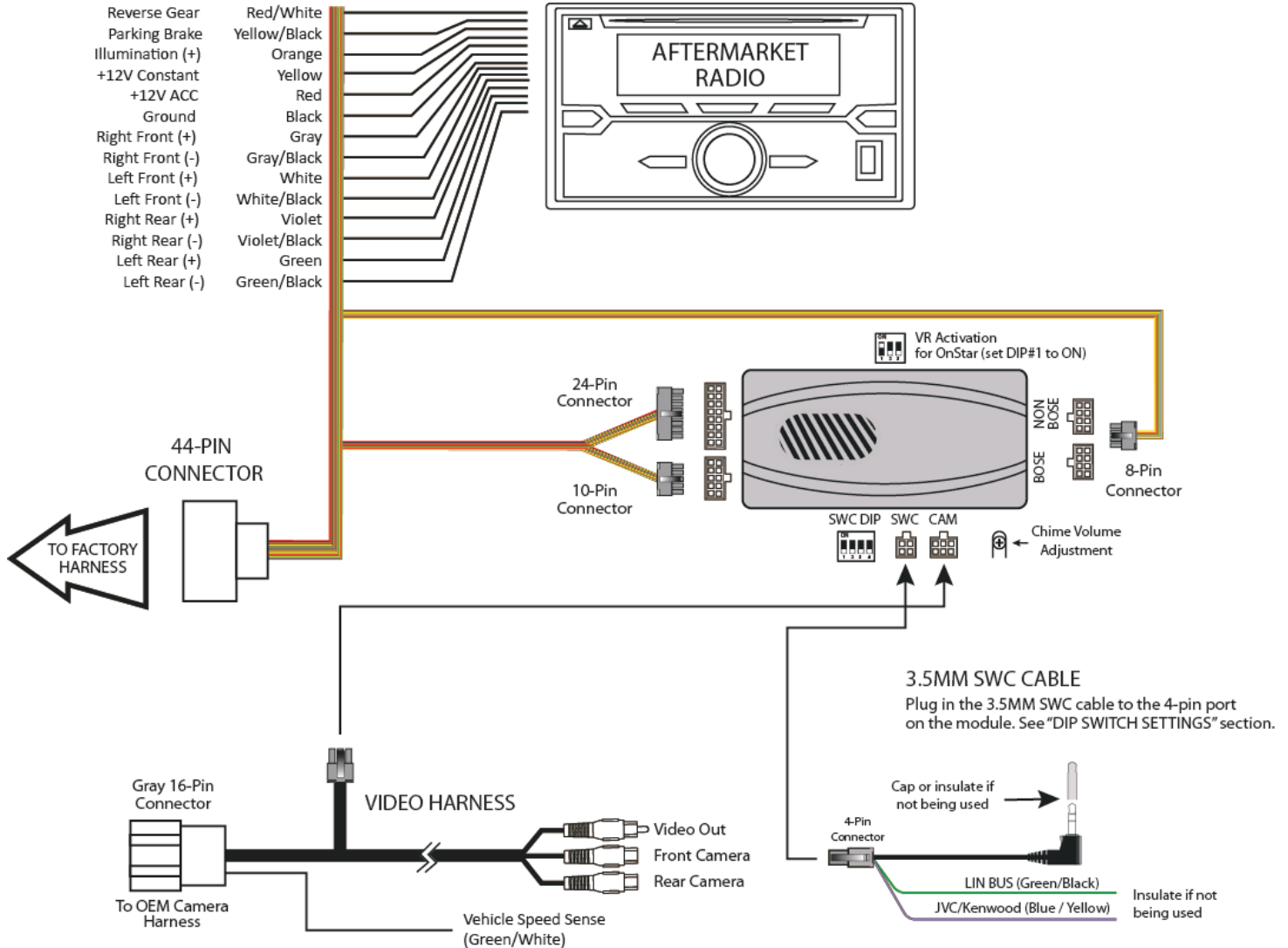

SELECTING THE AUDIO SYSTEM:

If the vehicle is equipped with a Bose system, the DKGM-16W has a built in Bose adaptor that allows the proper audio input gain from the aftermarket radio to the Bose amplifier. To use this feature, plug in the male 8 pin connector on the harness to the GRAY female 8 pin connector on the DKGM-16W module. The module is also labeled "Bose" and "Non Bose" to avoid confusion. (see picture below)

If the vehicle is not equipped with a Bose system, plug in the male 8-pin connector to the Black female 8-pin on the DK-GM16W module.

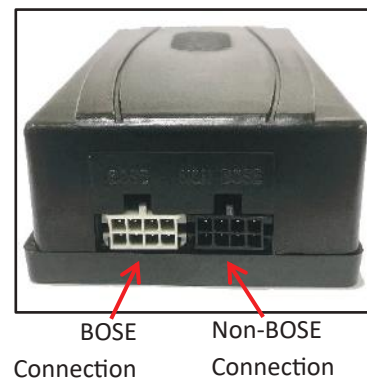



CHIME VOLUME ADJUSTMENT:

The DKGM-16W has a potentiometer to adjust the chime volume. It is set at half way by default. To adjust the volume, simply use a suitable screw driver and turn the potentiometer clockwise to increase the volume and counter-clockwise to decrease the volume.

Chime
Volume
Adjustment

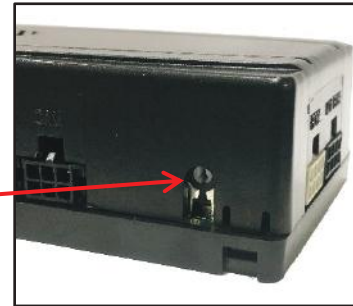

ONSTAR VOLUME ADJUSTMENT:

To adjust the OnStar volume, turn on OnStar and adjust the volume using the Steering Wheel Control volume adjustment. Once it is set, the DKGM-16W will memorize this level.

REAR SEAT ENTERTAINMENT (RSE):

Part# **CJA2333A** can be special ordered to retain the Rear Seat Entertainment (RSE).

1. Connect the rear seat entertainment 16-pin connector to the vehicle's 16-pin factory connector.
2. Connect the RCAs to the aftermarket radio audio and video inputs.
3. Test the audio and video before installing the radio into the dashboard.

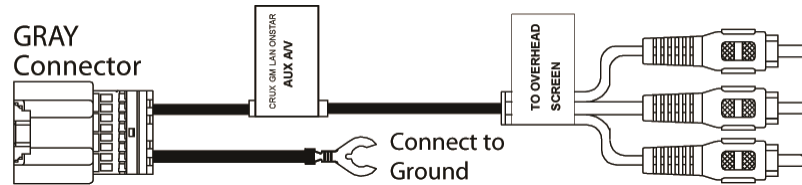

Part# CJA2333A (Not Included)

BACK UP CAMERA CONNECTION:

The DKGM-16W includes a video harness that allows a front and rear view camera to be plugged in and viewed on the aftermarket radio screen. The video harness includes a 20-pin brown connector that plugs into the OEM rear view camera harness to retain the use of the OEM rear view camera (if equipped). The two female video RCAs are used to connect an aftermarket front and rear view camera (if vehicle is not equipped with an OEM rear view camera).

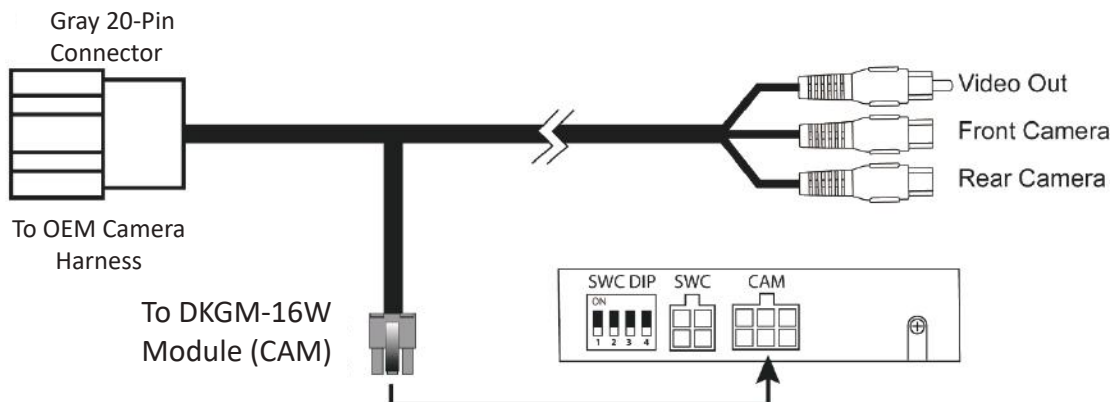





REVERSE WIRE CONNECTION:

For vehicles with a factory reverse camera installed, the factory camera module must be powered up to enable the forced view feature of the DKGM-16W . Connect the Reverse Gear Wire (RED/WHITE) on the DKGM-16W harness to the reverse camera power wire located on the reverse camera module or BCM. The factory reverse camera module or BCM can be found in different locations in the vehicle depending on the year and model. The chart below will aid in locating the reverse camera module or BCM.

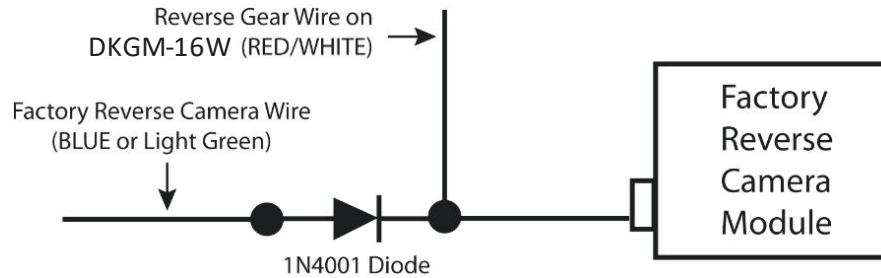
Use a 1N4001 diode to isolate the factory reverse camera power wire. See diagram below.



YEAR/MODEL	LOCATION	WIRE COLOR	
2007 – 2008 All Models	Under front passenger seat	BLUE Pin 1 of 8-pin connector	
2009 Avalanche, Suburban, Tahoe, Yukon	Junction block next to the steering column	BLUE Pin 8 of Gray connector	
2009 Silverado, Sierra	BCM to the left of the steering column	Light Green Pin 2 of connector 7	





FORCED CAMERA FEATURE:

The DKGM-16W can force the aftermarket radio to show the front¹ or rear video camera on select GM trucks and SUV's with power mirror controls at any time while driving. To force the front or rear camera while driving do the following...

1. Set the power mirror selection to off (both LED lights must be off on the power mirror switch). You can turn off the LED by pressing the button on the same side that the LED is currently lit. Note: Turning off the mirror selection will prevent the mirrors from being adjusted while forcing the front/rear camera mode.
2. To force the Front camera mode, press and hold the Up arrow on the 4-way joystick until the video shows on the aftermarket radio.
3. To force the Rear camera mode, press and hold the Down arrow on the 4-way joystick until the video shows on the aftermarket radio. (If the vehicle is not equipped with a factory backup camera, an aftermarket backup camera can be installed and plugged into the DKGM-16W backup camera video harness)
4. To turn Off forced camera mode, press and hold the 4-way joystick Up arrow if in front camera mode or Down arrow if in rear camera mode. Wait until the video turns off on the aftermarket radio then release the 4-way joystick.
5. The reverse camera has priority over the front camera when driving the vehicle in reverse.



¹ (Requires installation of aftermarket camera)

ENABLING THE RSE IR SYSTEM:

To retain the use of the IR headphones with the factory overhead entertainment system you will need to connect a +12 volt switched accessory power wire to the rear entertainment panel wire harness located in the rear of the center console. You will need a 1 amp fuse and a 1N4001 diode to complete the installation. Remove the RSE control panel in the center console. Tools will be required such as a panel remover tool and/or 7mm socket. Locate the (pink) wire located in pin 14 of the (gray) connector. Connect the diode's stripe side to the pink wire. Connect the other end of the diode to one side of the 1 amp fuse. Connect the remaining side of the fuse to a +12 switched accessory wire. Refer to the wiring diagram below.

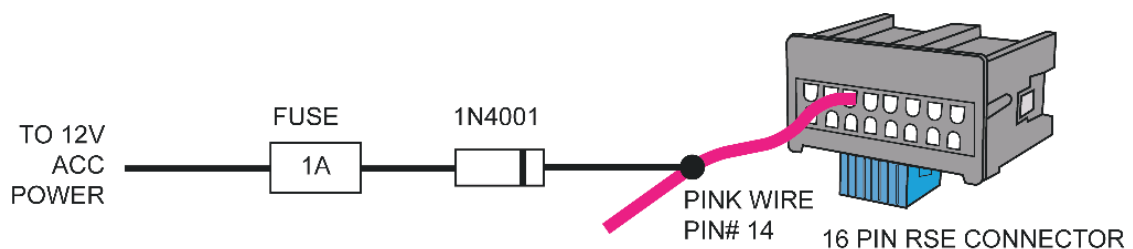



STEERING WHEEL CONTROL BUTTON FUNCTIONS:

SWC buttons	All radios except Sony	Sony
Short press		
VOICE	Mute	Mute
VOLUME_DOWN	Volume Down	Volume Down
VOLUME_UP	Volume Up	Volume Up
TRACK_UP	Track up/Seek Up	Track up/Seek Up
TRACK_DOWN	Track dn/Seek dn	Track dn/Seek dn
SOURCE	Source	Source **
RIGHT_ARROW	Preset up	Preset up
Long press		
VOICE	VR/OnStar *	VR/OnStar *
VOLUME_DOWN	Volume Down Continuous	Volume Down Continuous
VOLUME_UP	Volume Up Continuous	Volume Up Continuous
TRACK_UP	Answer Call	
TRACK_DOWN	End Call	Reject call
SOURCE		
RIGHT_ARROW		

- 1 = VOICE
- 2 = VOLUME UP/DN
- 3 = TRACK UP/DN
- 4 = SOURCE
- 5 = RIGHT ARROW



* You can enable the factory steering wheel Voice button to activate Voice Recognition (VR) on the aftermarket radio. If your radio doesn't support VR you can assign the Voice button to activate OnStar by turning on DIP switch #1 on the 3 position DIP Switch. See diagram on page 2.

** During an incoming/current call the Source button will Answer and End call.



DASH KIT INSTALLATION:

A double DIN radio replacement dash kit is included in the kit to make the installation quick and easy. You have the option of installing a Double DIN or two Single DIN radios. The DKGM-16W kit includes:



INSTALLATION:

Before installation:

1. Locate the main trim.
2. Locate the left and right mounting brackets.
3. Slide the appropriate mounting bracket into the trim ring, aligning the holes in the trim ring to the clips on the bracket. (See Diagram B)
4. For two Single DIN radio installation, slide the stacked ISO DIN unit into the trim ring bracket assembly and secure the unit to the kit using the screws supplied with the radio. (See Diagram C)

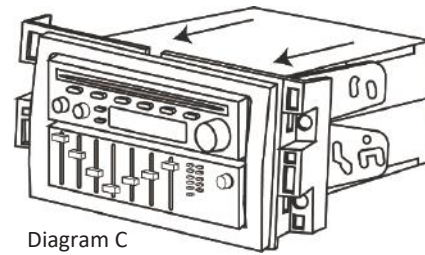
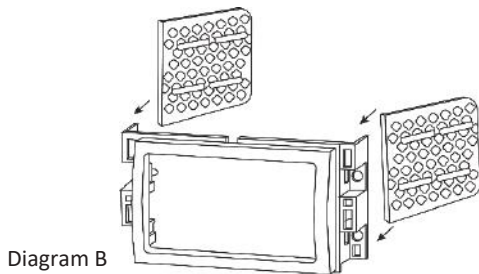

VEHICLE APPLICATIONS:

CHEVROLET

2012-2013 Avalanche
 2012-2014 Silverado 1500-3500 Pickup
 2012-2014 Suburban
 2012-2014 Tahoe

GMC

2012-2013 Sierra 1500-3500 Pickup
 2012-2014 Yukon

